

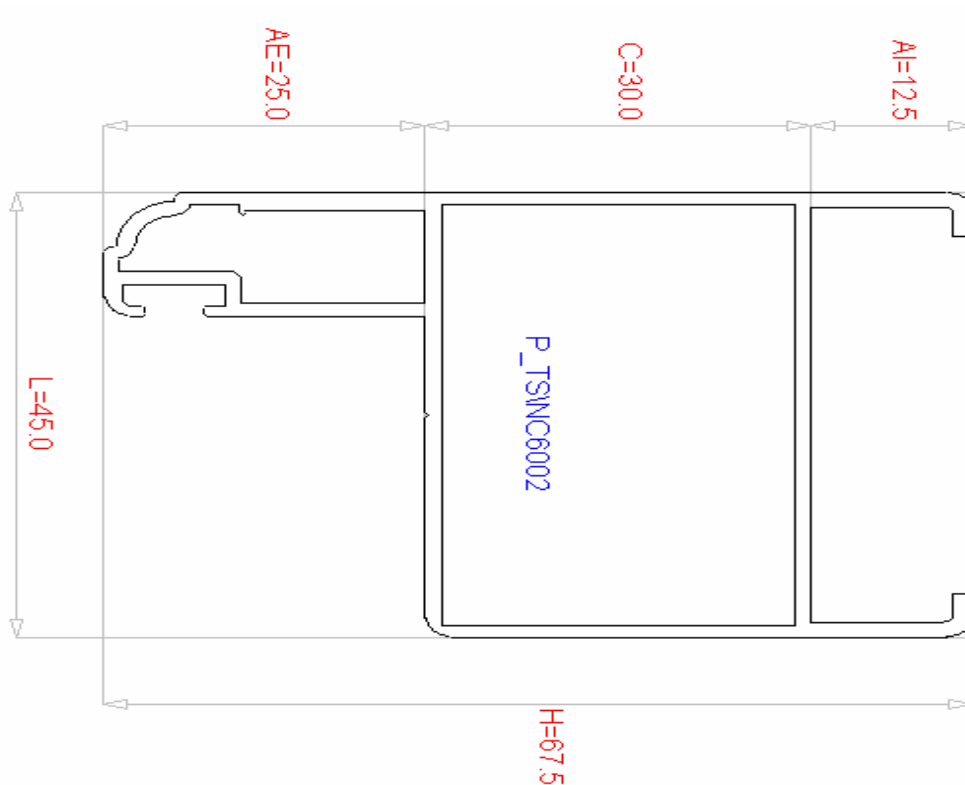

Sezioni Profili Utilizzati

Profilo Perimetrale Anta

NC6002



Lamella a Goccia da 65 mm

R4424

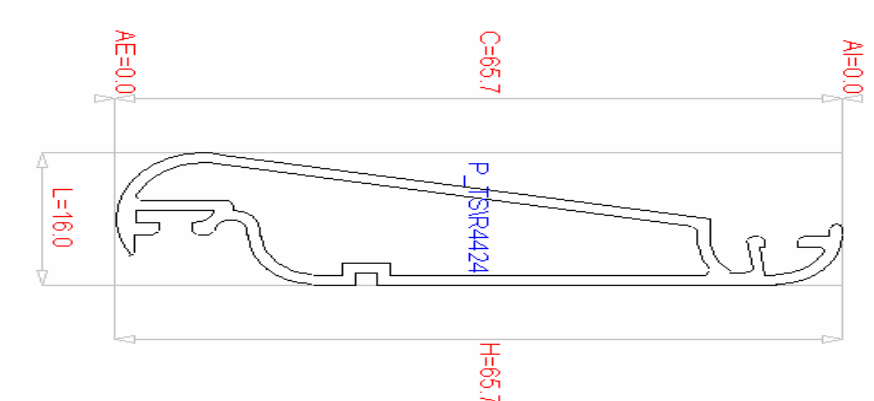



Mezza Lamella

R6353

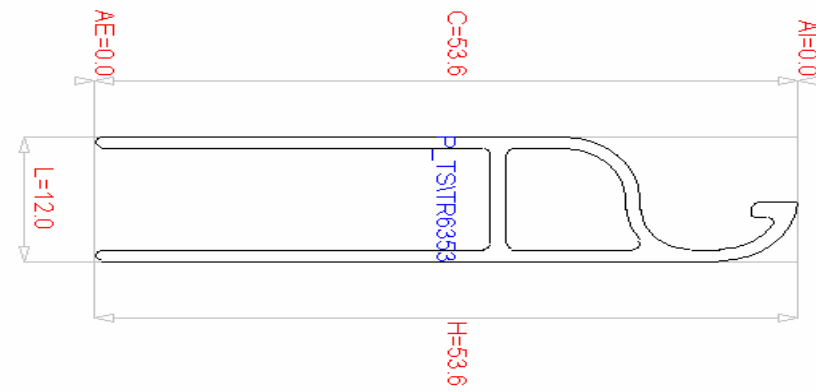

Compensatore

B 976

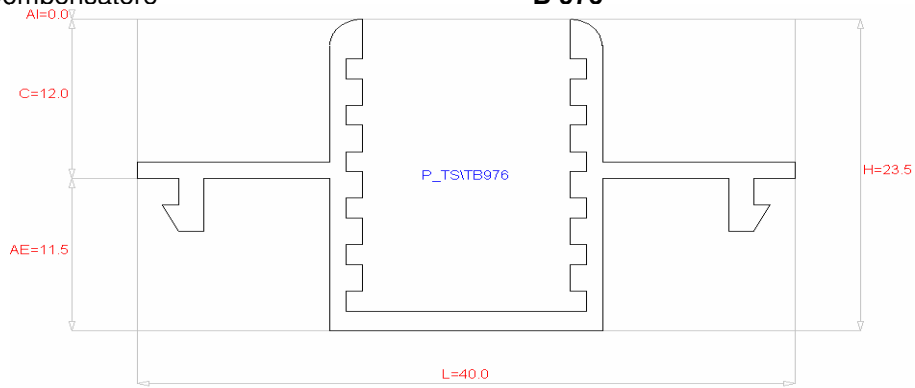

Riporto Centrale per Scambio Battute 2, 3 e 4 Ante

NC3921

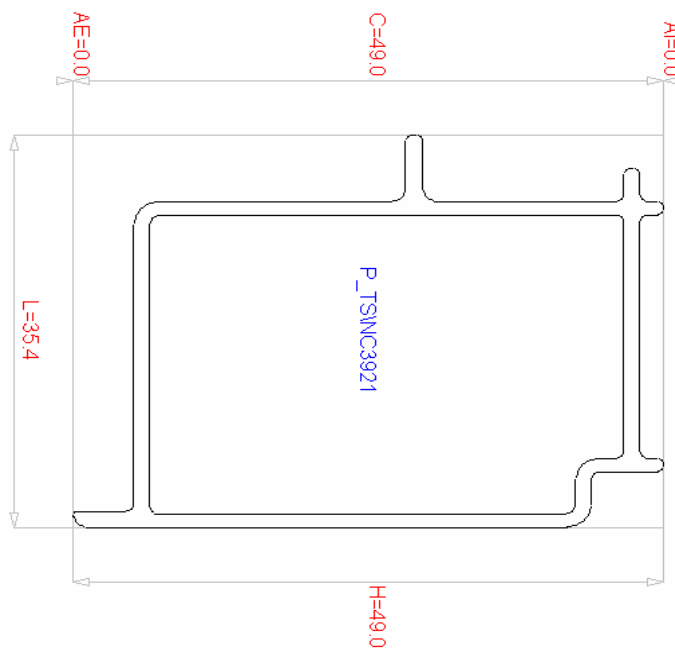



Zoccolo inferiore e Traverso Portafinestre per esecuzione Z3B

NC3736

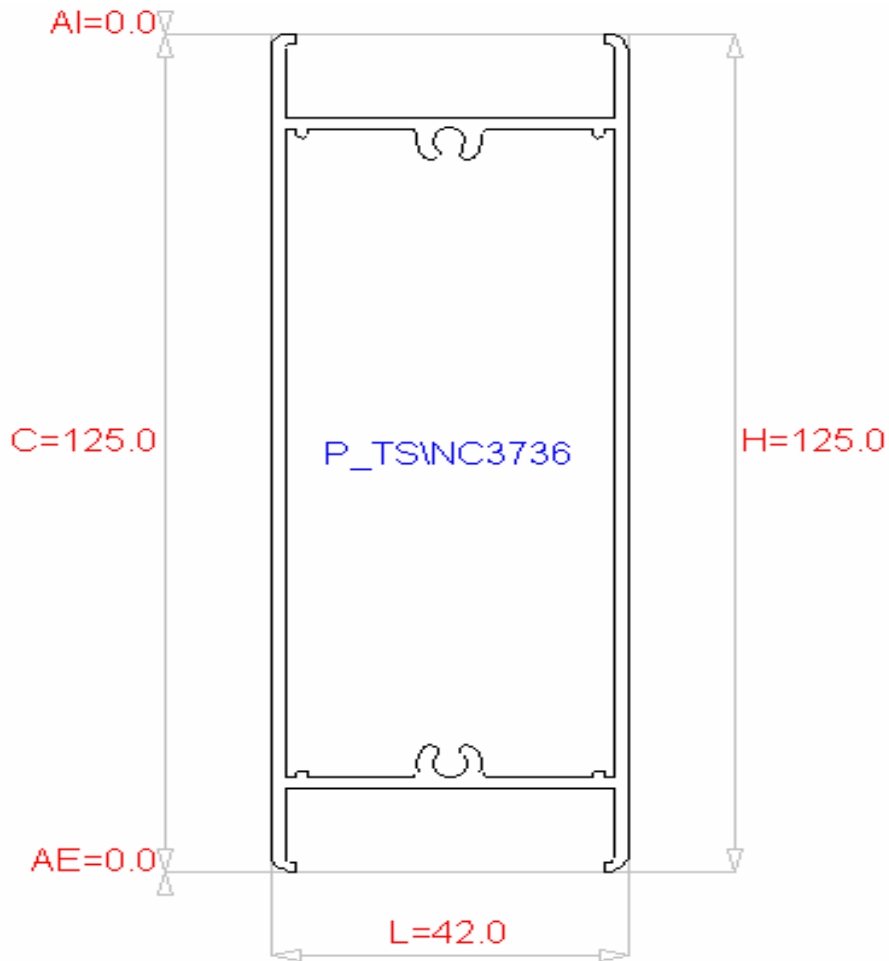

Traverso Portafinestre per esecuzioni SZ4B e SZ3B

NC3739

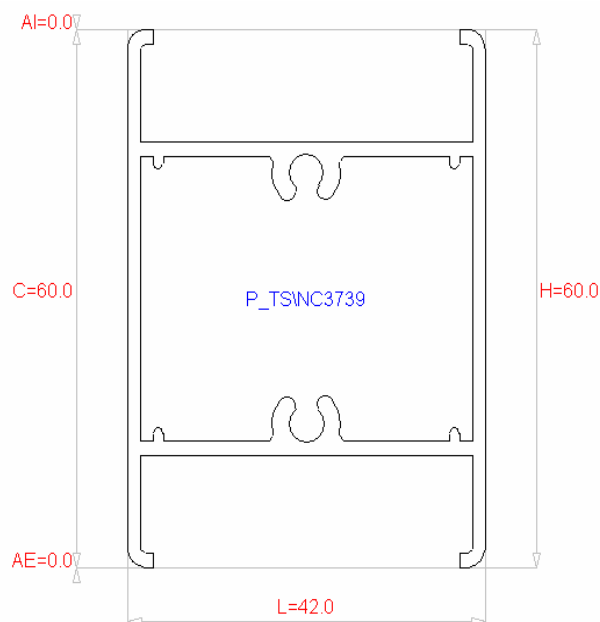



Copricava inferiore per finestre con Zoccolo **NC3933**

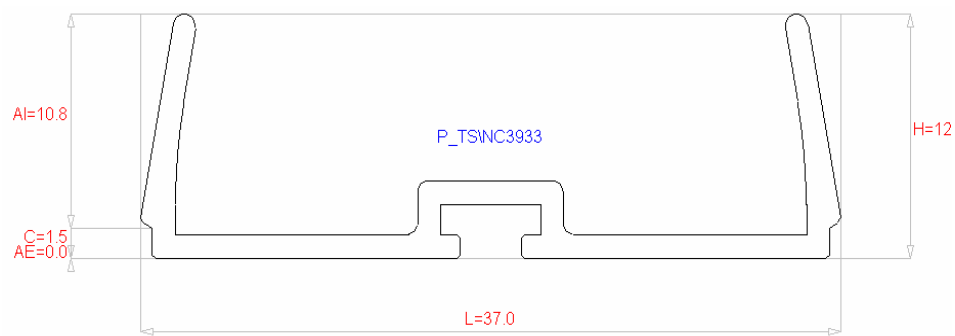

Riporto inferiore per esecuzione SZ3B e per Scorrevoli **NC3923**

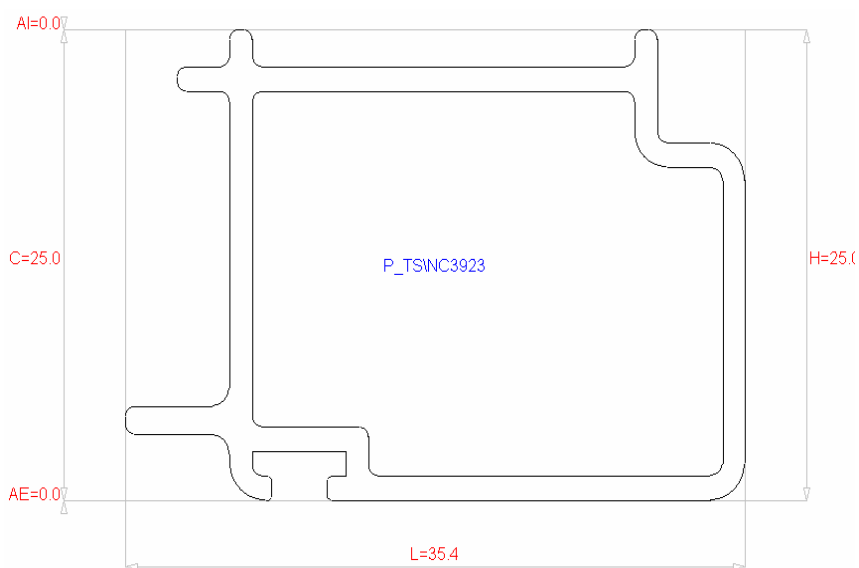



ESECUZIONI STANDARD

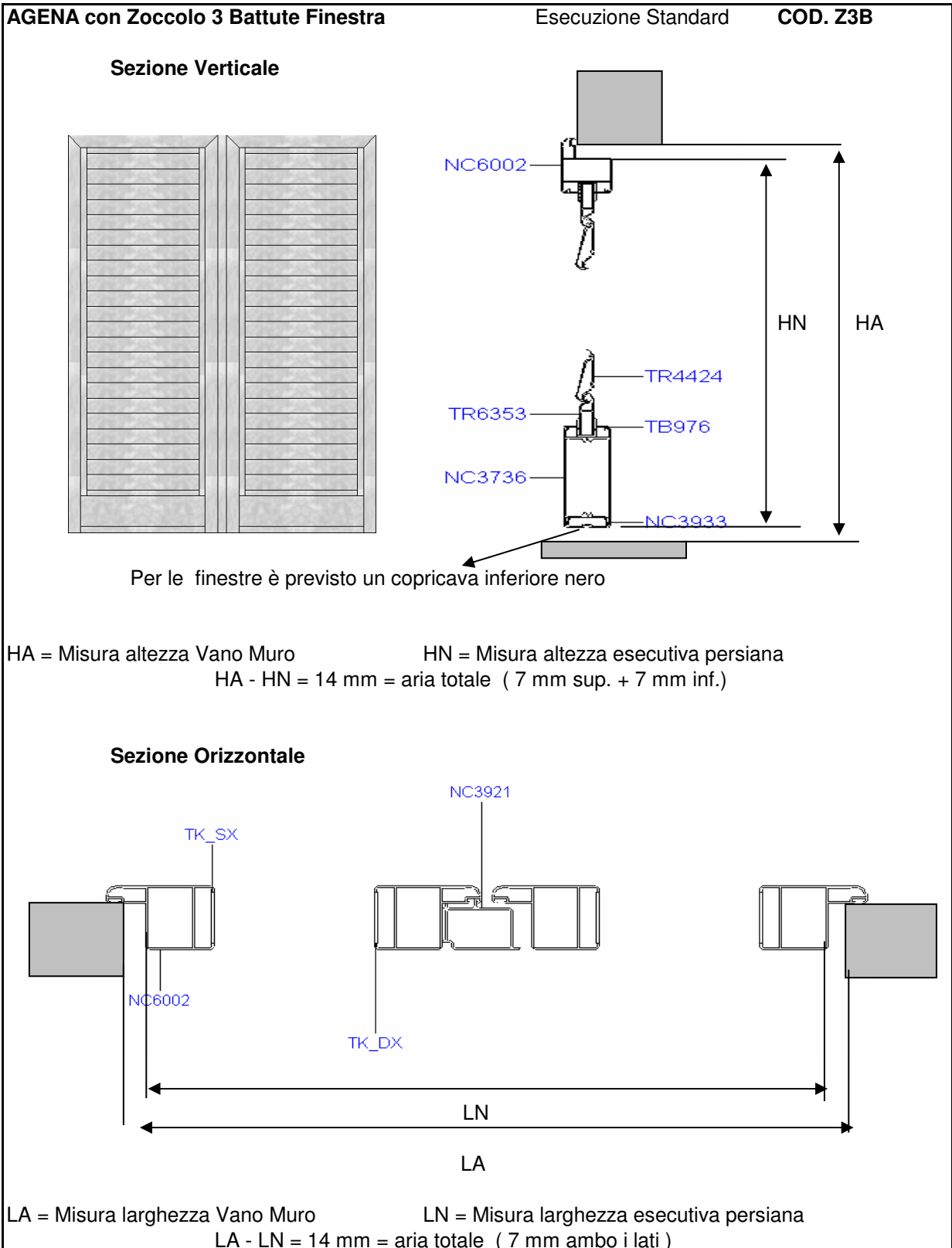

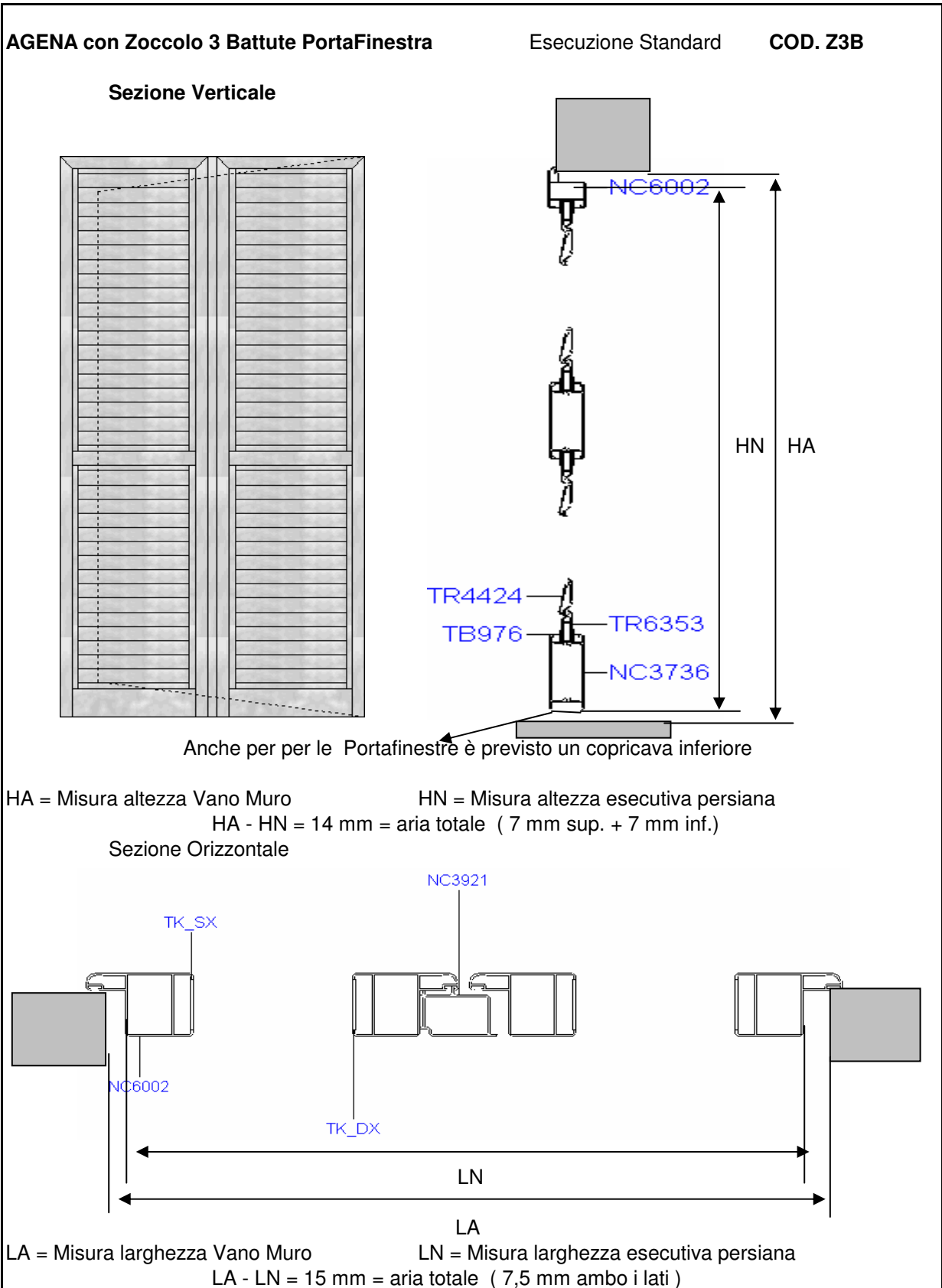

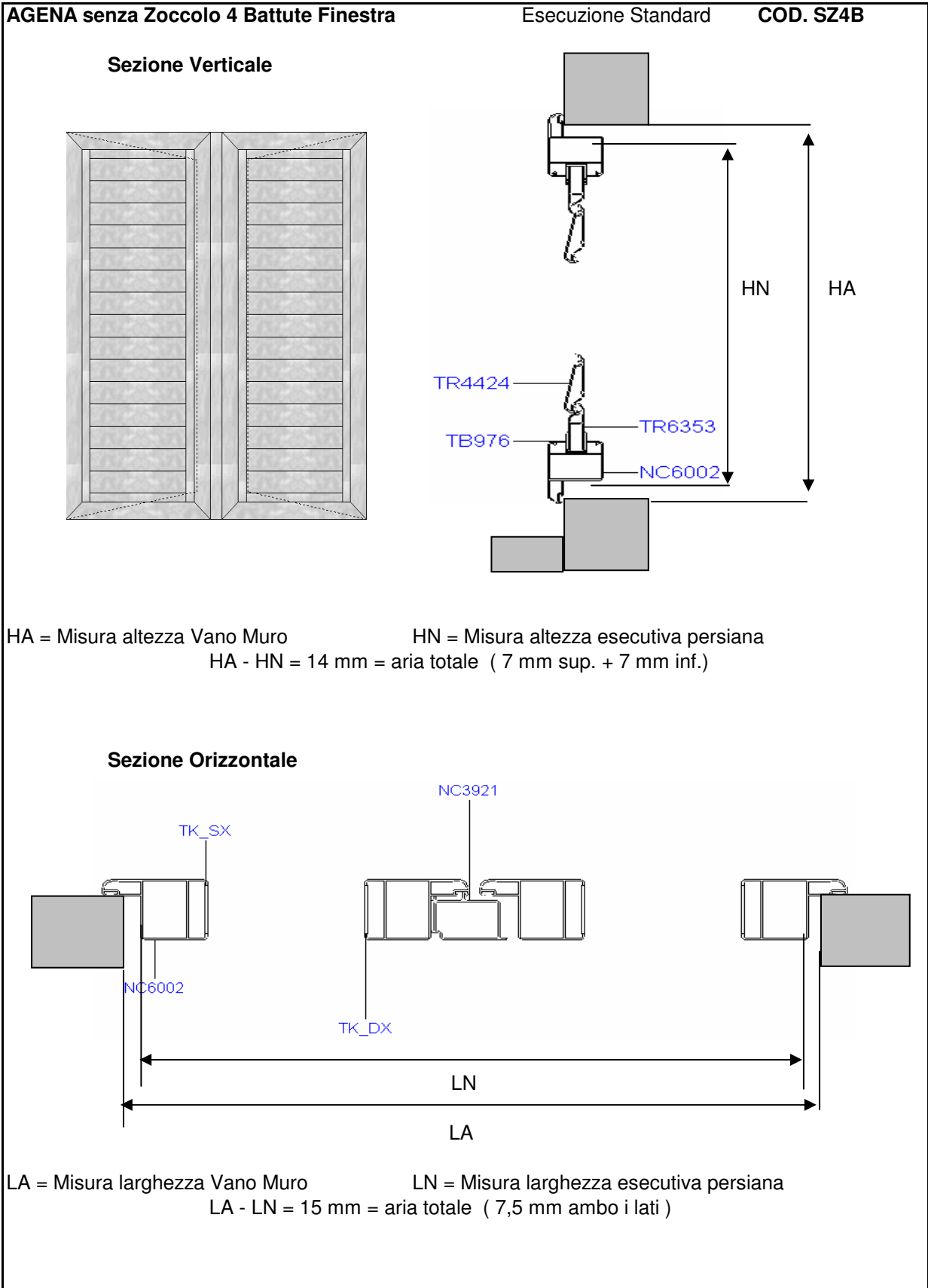



AGENA senza Zoccolo 4 Battute PortaFinestra

Esecuzione Standard

COD. SZ4B

Sezione Verticale

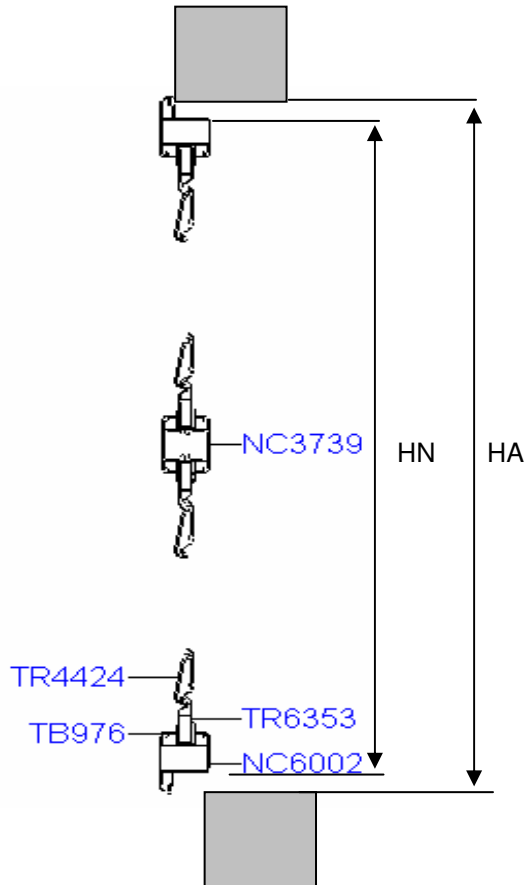
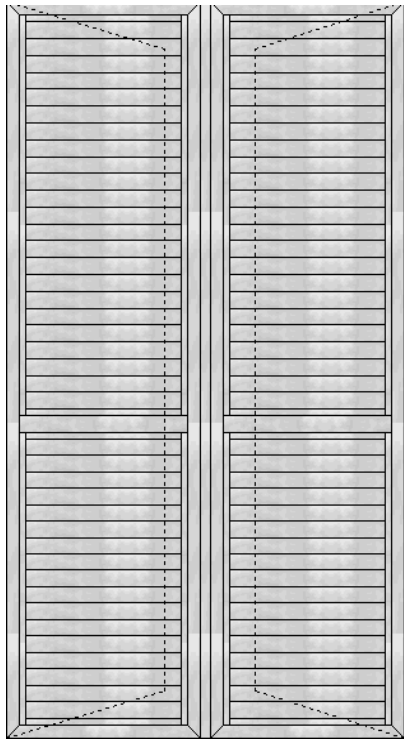

HA = Misura altezza Vano Muro

HN = Misura altezza esecutiva persiana

HA - HN = 14 mm = aria totale (7 mm sup. + 7 mm inf.)

Sezione Orizzontale

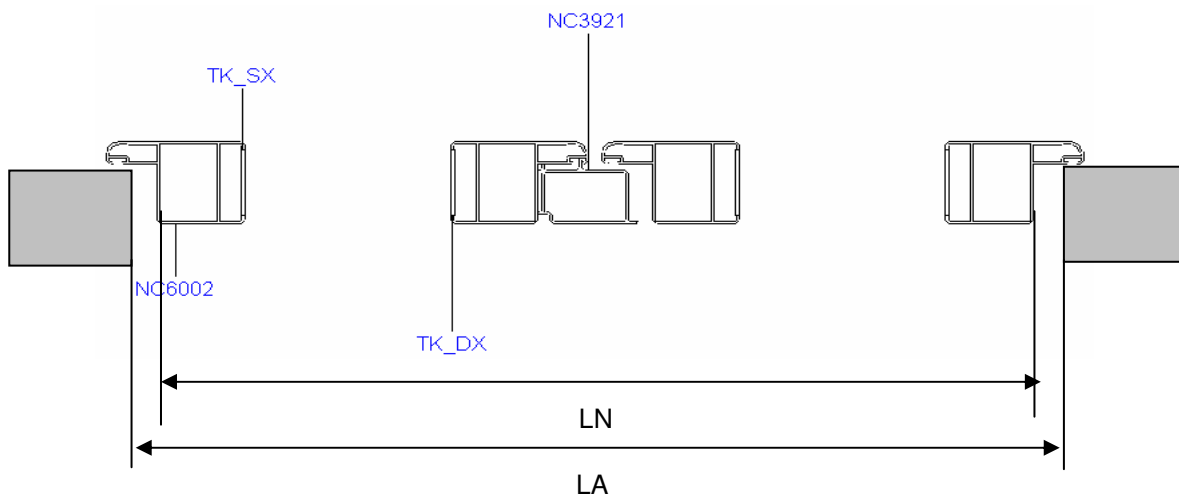

LA = Misura larghezza Vano Muro

LN = Misura larghezza esecutiva persiana

LA - LN = 15 mm = aria totale (7,5 mm ambo i lati)



ESECUZIONI NON STANDARD

AGENA senza Zoccolo 3 Battute Finestra

COD. SZ3B

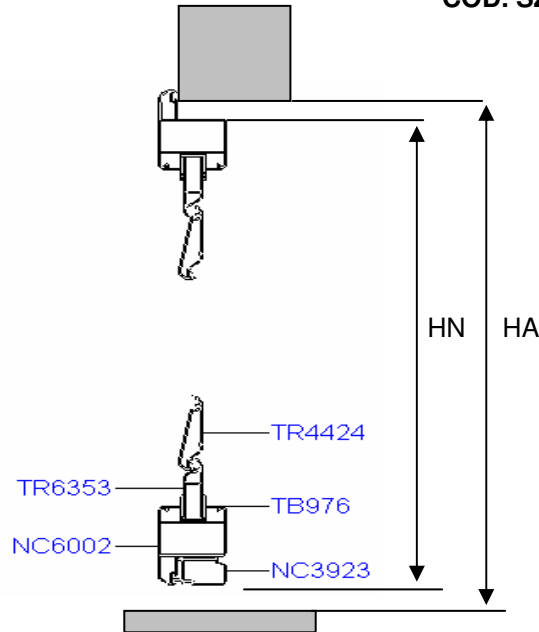
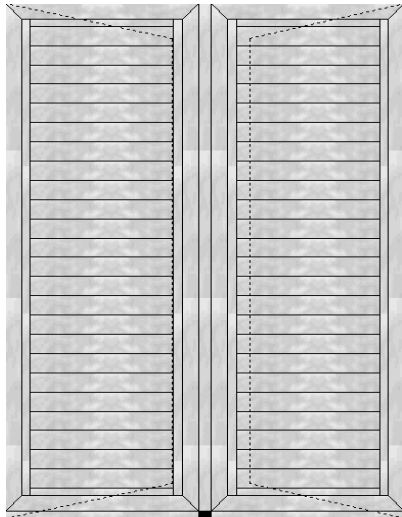

AGENA senza Zoccolo 3 Battute PortaFinestra

COD. SZ3B

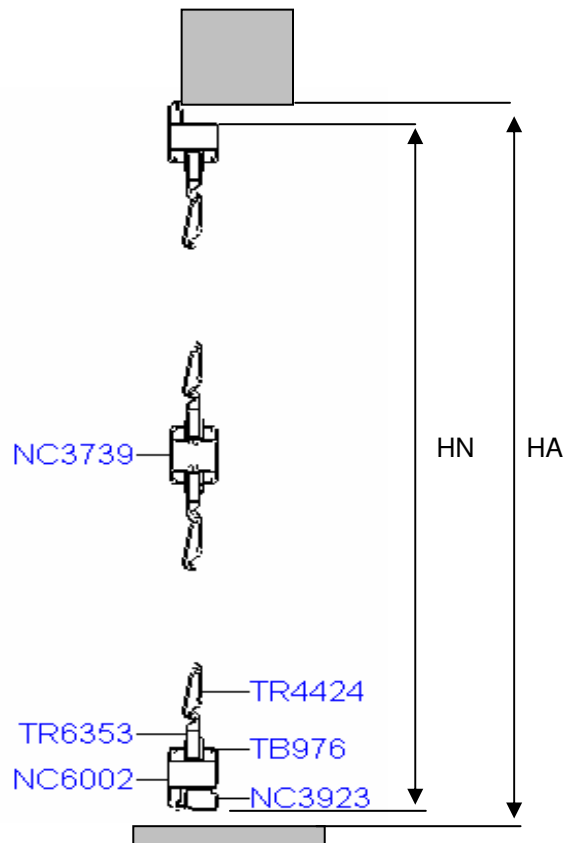
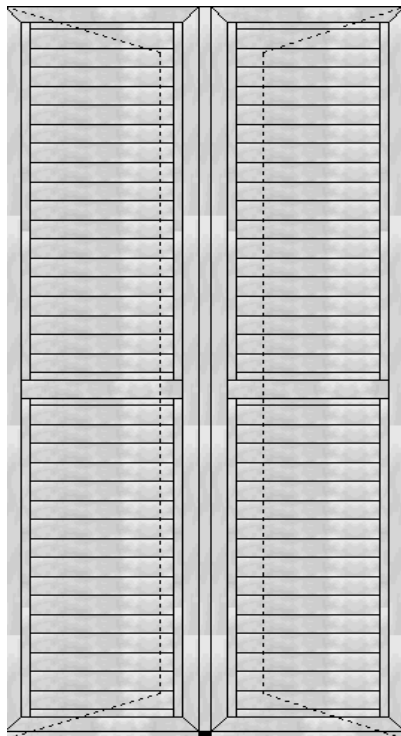



Esecuzione Finestra con 1 Traverso

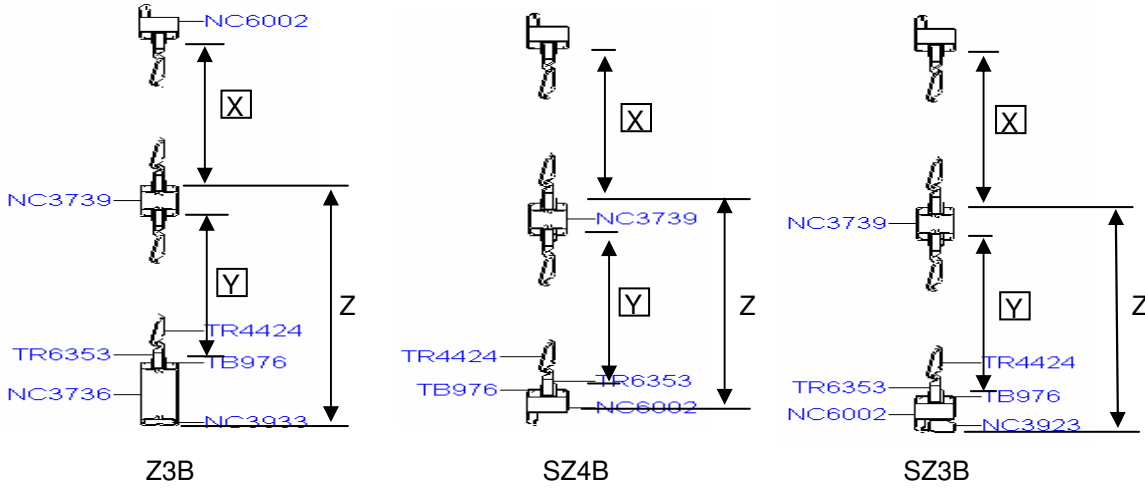

Esecuzione con Traverso Simmetrico ($X = Y$)
 Esecuzione con Traverso asimmetrico (Fornire misura Z)

COD.: **TS**
 COD.: **TAS-Z=**

Esecuzione Portafinestra con 2 Traversi

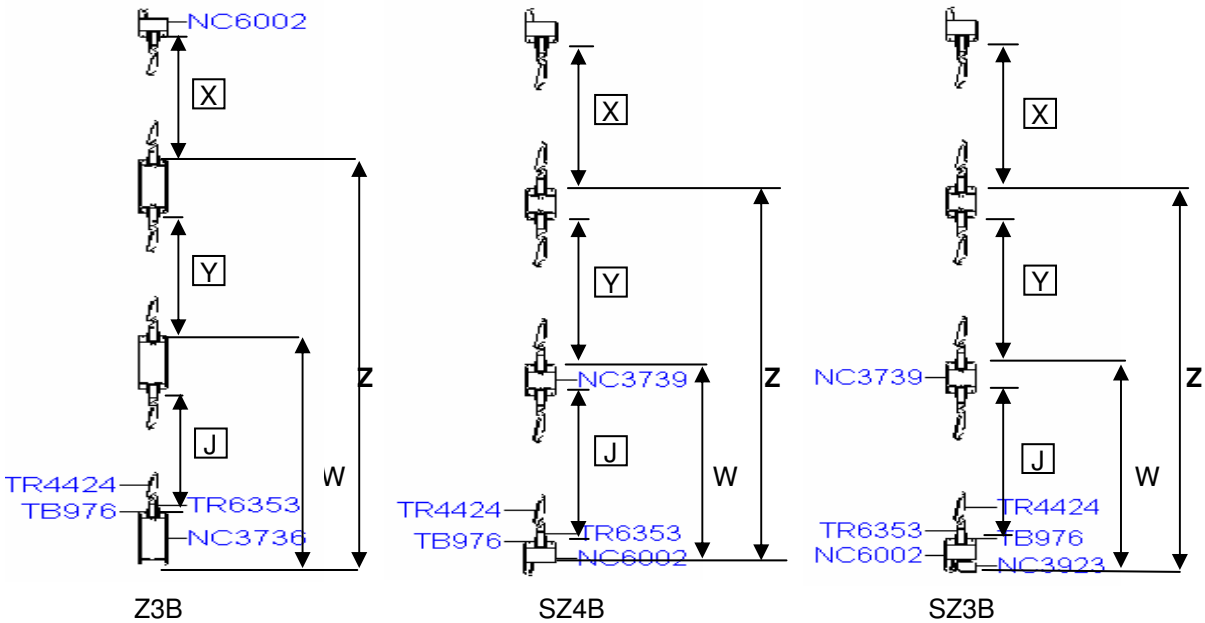

Esecuzione con 2 Traversi Simmetrici ($X = Y = J$)
 Esecuzione con 2 Traversi Asimmetrici (Fornire misure W e Z)

COD.: **2TS**
 COD.: **2TAS-W=; Z=**



Esecuzione con Sportello apribile alla Genovese

Finestra

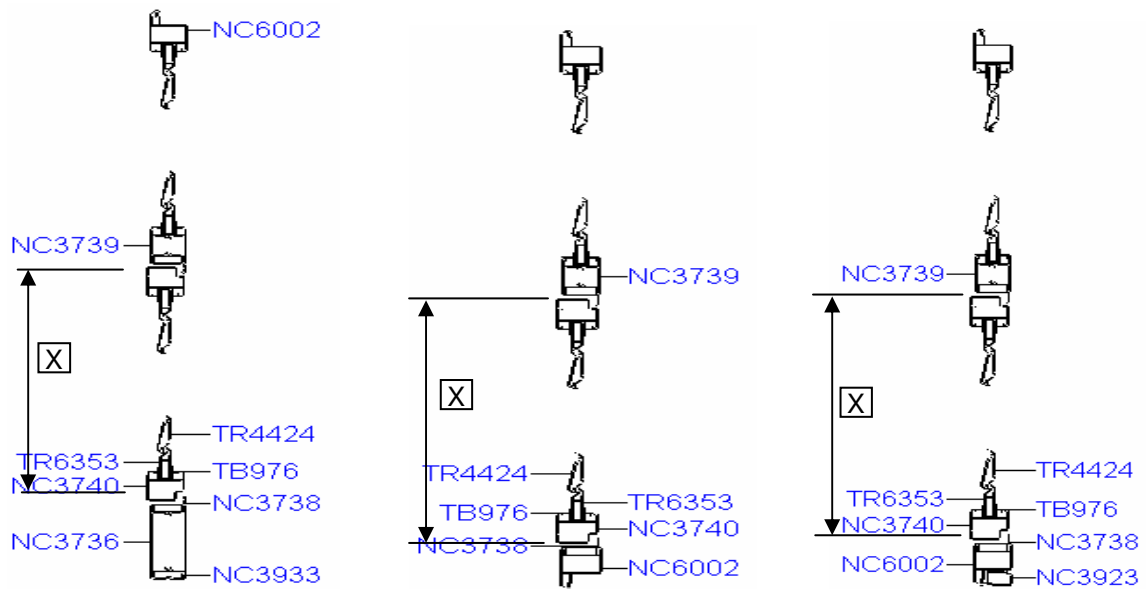
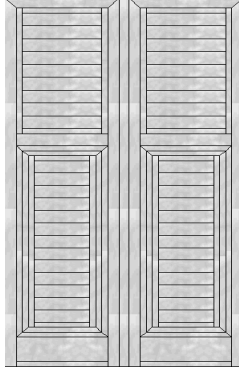

Altezza Standard X = 800 mm

Per Finestre con altezza inferiore a 1000 mm
esecuzione con sportello intero

Altezza non Standard

COD. SPGE-X =



Portafinestra

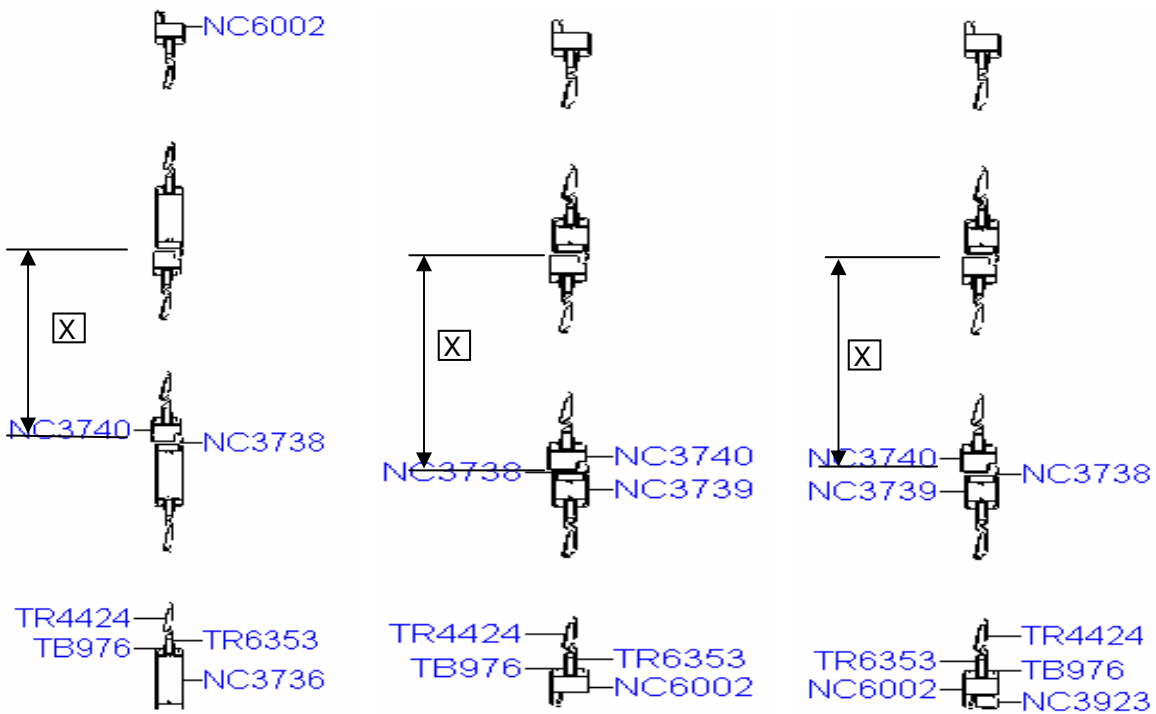
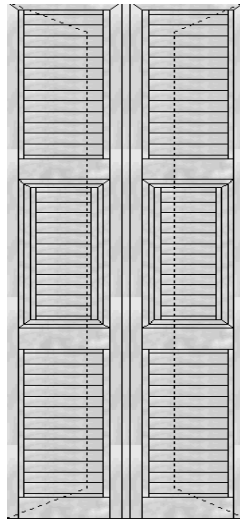

Altezza Standard X = 800 mm

Altezza non Standard

COD. SPGE-X =



VARIAZIONI

Variazione Misura Altezza Traverso su Portafinestra COD.: SHM-Z=

Altezza Traverso Standard : Z = 986 mm

Variazione Misura Altezza Maniglia Spagnoletta su Finestra e Portafinestra e Serratura su Portafinestra COD.: SHM-X=

Altezza Maniglia Spagnoletta Standard X = (HN/2) - 50 mm per Finestre fino a HN = 1.000 mm
 Altezza Maniglia Spagnoletta Standard X = 580 mm Per Finestre Oltre a HN = 1.000 mm
 Altezza Maniglia Spagnoletta Standard X = 1.080 mm per PortaFinestre

Altezza Maniglia Serratura Standard X = 1150 mm